

CHUBBSAFES EVOLVE

INSTRUCTION MANUAL



Table of content

1- CHARACTERISTICS	4
1-1 Models	4
1-2 Dimensions & Weights.....	4
1-3 Interior fittings (standard and optional).....	5
2- TRANSPORTATION	6
3- RECOMMENDATION BEFORE INSTALLATION	7
4- INSTALLATION.....	8
4.1 - Positioning	8
4.2 Base fixing	9
5- LOCK DESCRIPTION	10
5.1 Warning indicators.....	11
5.2 User access level	11
5.3 Opening code	11
6- USING THE SAFE / LOCK.....	12
6.1 Type of product.....	12
6.2 Opening the door of the safe.....	12
6.2.1 Opening without delay.....	12
6.2.2 Opening with delay	13
6.2.3 Dual access opening without delay (four eyes mode).....	14
6.2.4 Dual access opening with delay (four eyes mode)	14
6.2.5 Securing the door.....	15
7- CHANGING AN OPENING CODE	16
7.1 Changing an opening code.....	16
8-ACTIVATING AND DEACTIVATING OPERATORS	17
8.1 Activating operators.....	17
8.2 Deactivating operators.....	18
9-SETTING DELAYS	19
9.1 Master code delay.....	19

9.2 Operator delay	20
10-DUAL ACCESS OPENING (4 eyes mode)	21
10.1 Activating the dual access opening mode (4 eyes mode).....	21
10.2 Deactivating dual access opening mode (4 eyes)	22
11- RECONFIRMING THE CODE	23
11.1 Activating the code reconfirmation after delay.....	23
11.2 Deactivating the code reconfirmation after delay.....	24
12-BUZZER.....	25
12.1 Activating the buzzer	25
12.2 Deactivating the buzzer	26
13- TROUBLESHOOTING.....	27
14- WARRANTY	27
15- MAINTENANCE PERIODS.....	27
16- FACTORY SETTINGS.....	28
17- THROW THE LOCKING BLADE (page 16)	29
18- WARNINGS AND PRECAUTIONS	30

1- CHARACTERISTICS

1-1 Models



1-2 Dimensions & Weights

	External (mm)			Internal (mm)			Weight	Door Weight	Body Weigh	Internal volume	Clear opening width
	H	W	D	H	W	D	KG	KG	KG	Liter	
S1	690	600	500	590	500	328	151	42	109	100	1055
S2	876	600	500	776	500	328	186	56	130	125	1055
S3	1200	600	500	1100	500	328	247	81	166	185	1055

1-3 Interior fittings (standard and optional)

Product	Main Features	Dimension & Weight KG	Picture
Adjustable Shelf	Steel 2 mm Powder Coated Side fixing brackets Chrome Capacity 60 kg	Model 100-185: 20mm H x 475mm W x 320mm D 2 kg Maximum load-bearing : 24kg	
Shelf Full Extension	Steel 2 mm Powder Coated Chrome Ball Bearing slide Full Ext load 30 kg	Model 100-185: 37mm H x 455mm W x 320mm D 5.5 kg Maximum load bearing :2.5kg	
Drawer Full Extension	Steel and Aluminum Construction Powder Coated Silver Chrome Ball Bearing Slides Full Ext Load 30 kg Silver Tray and Support	Model 100-185 102mm H x 488mm W x 316 mm D 10 kg Maximum load bearing :4kg	

2- TRANSPORTATION

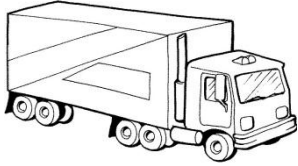

RECOMMENDATION:

The safe is heavy so it must be transported and handled by a professional installation company.

For safe transportation the safe is based fixed to the pallet.

3- RECOMMENDATION BEFORE INSTALLATION



IMPORTANT:

- To enable correct functionality of the safe, please ensure that it is set level.

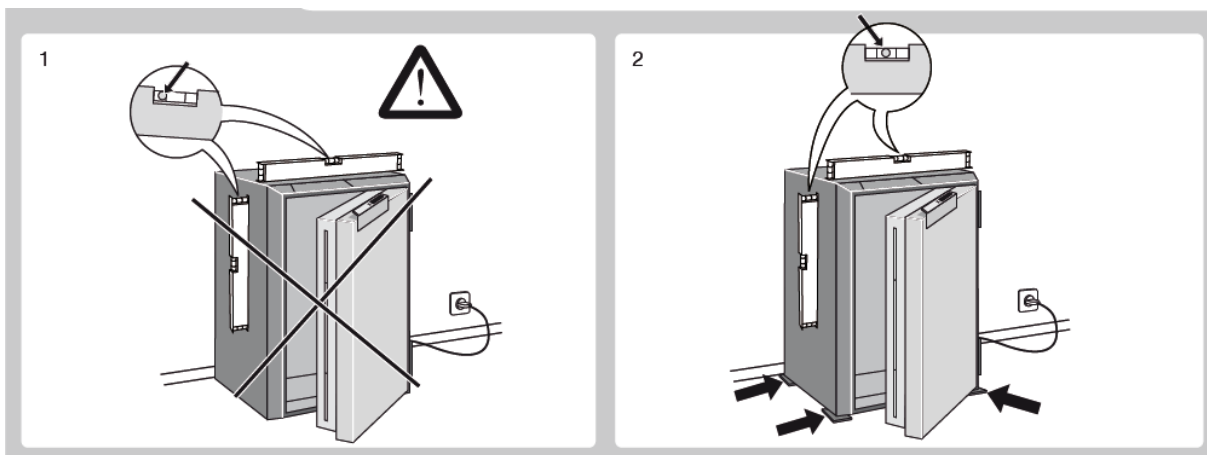

Before installation / set up, ensure that the installation location has sufficient weight bearing capacity (see page 31).

- **Always anchor** the safe to the floor to ensure the required level of safety (for persons and for the content of the safe).

- **Anchoring operation must be done** by professional staff referring to the user guide and anchoring procedure delivered with the safe.

4- INSTALLATION

4.1 - Positioning

- 1- Position the safe in a definitive location.
- 2- Ensure that the safe is level by using a spirit level. (uses wedges if required)
- 3- Plug the safe in the mains and then open the door.
- 4- check that there is no door swing (i.e. that the door is flush)
If there is any swing please review the wedging.

NOTE: Mark the drilling point if it is necessary to shift the safe before drilling

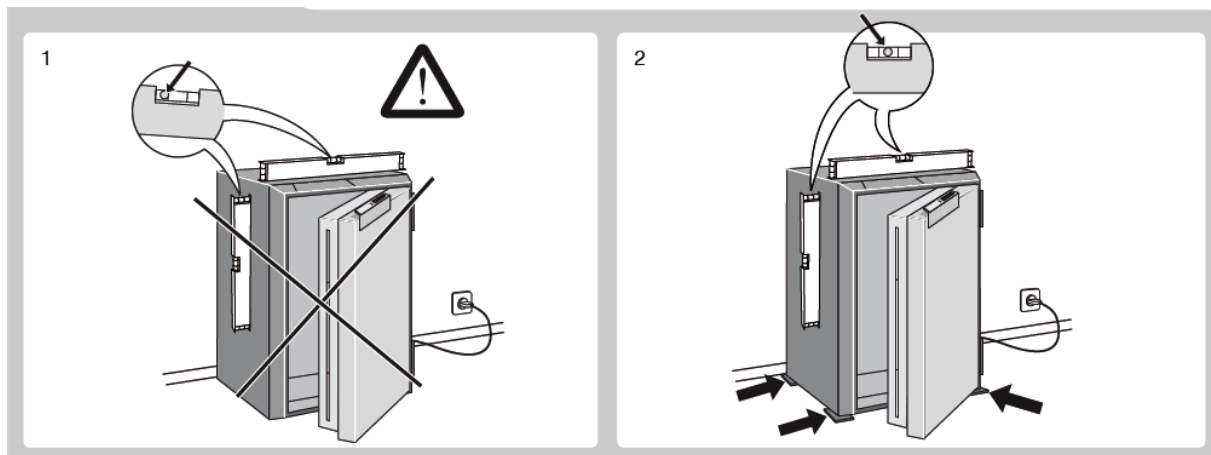

IMPORTANT:



- The safe needs to be level for a good opening and closing of the door.
- When closing the door, do not hand on the top of the door, but push the door with the hand as shown below.

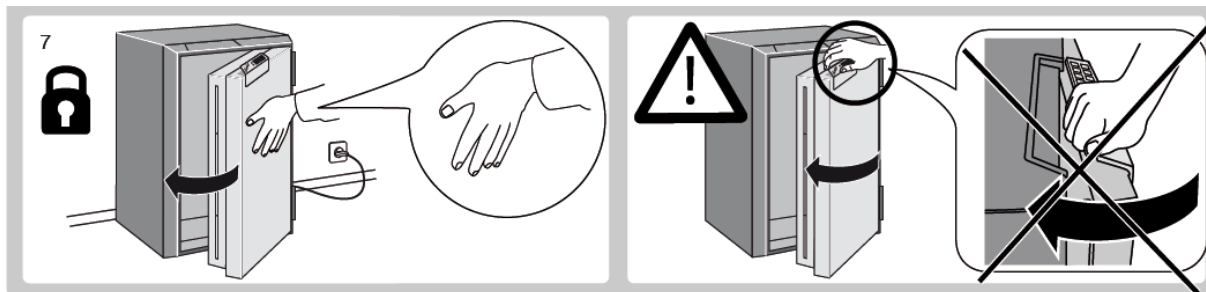

4.2 Base fixing

- All safes are prepared for base fixing.
- A M16 expansion bolt is supplied with the product.
- For a compliant fixing, follow the different steps below.

Tools :

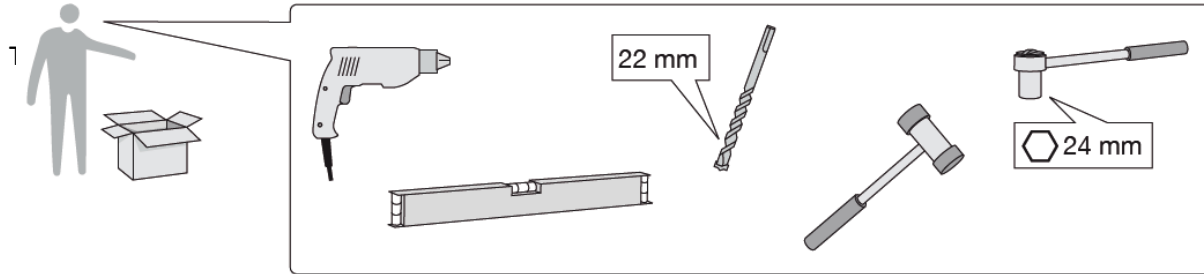

Fixing procedure:

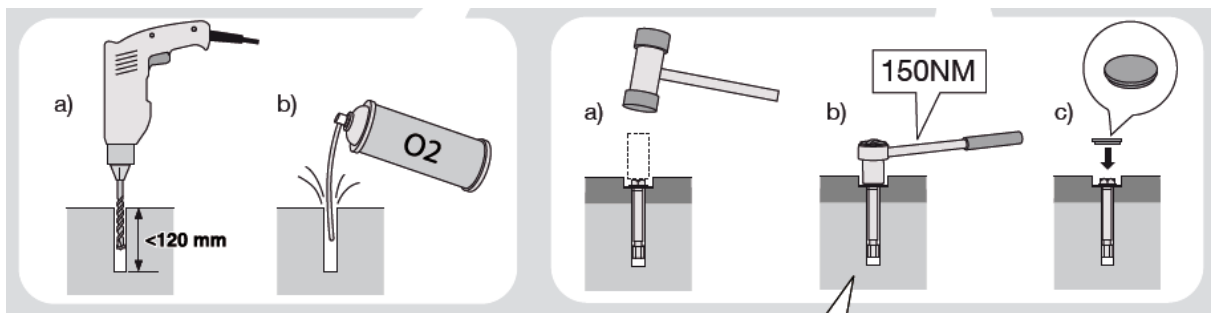

IMPORTANT: For a compliant fixing, the expansion bolt supplied with the safe must be fixed in a concrete compressive support of 250 bars and the tightening torque must be of 150NM.

5- LOCK DESCRIPTION

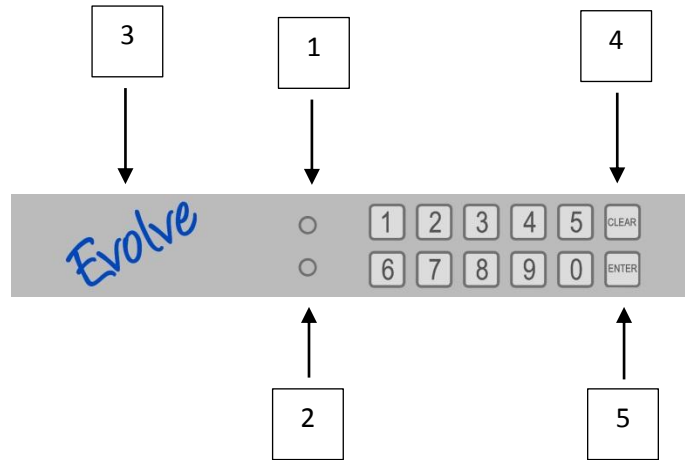

1- Green Light.







2- Red Light.

3- Keypad = a sound (beep) is emitted when a key is pressed.

4- Clear = manually relocks the lock and erases any input.

5- Enter = validation of input.

Signaling:

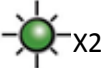
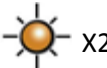
		Switched off
		Switched on
		Blinking
		blinking twice

5.1 Warning indicators

- Each correct action is confirmed by 2- beep sounds with 2 green Light flashes.
- An incorrect action will be alerted by 3-beep sounds with 3 red light flashes.
- The green Light is flashing intermittently = The safe is unplugged
- The red light is flashing = The battery is low

5.2 User access level

Three access levels are possible:

- Master code
- 7 operators
- CIT (cash in transit)

The master code is the only code which allows the user to activate, inactivate or change a code.

The master, operator and C.I.T codes can open the lock.

To avoid any opening problem (lost code), we recommend that you activate at least 2 operator codes.

5.3 Opening code

The opening code can be made up of 6, 7 or 8 digits.

For default code, please refer to chapter 6: "Factory settings"



For maximal security, avoid using codes such as 000000, 999999, 1234567, 7654321, etc.

6- USING THE SAFE / LOCK

(IMPORTANT: No children under 12 should operate the safe).

6.1 Type of product

The safe works as an electronic boltwork control with a lock powered by an internal 12 Volts power supply and a 12V, 4,5A.h battery;

- When unplugged, after 1 minute the green Light on the keypad will begin to flash intermittently to indicate the safe is unplugged.
- When the battery power is low the red light will flash.
- When the red light is flashing the only way the safe can be opened is by connecting it to the mains supply.







When unplugged and the battery is *fully charged, the safe will normally be operable for three days and for 5 opening / locking routines per day.

(* The battery is fully charged when the safe has been plugged in the mains for 2 days)

6.2 Opening the door of the safe

Depending on the settings, the lock can be opened in the following ways:

6.2.1 Opening without delay

	Red light	Green light
- Type an opening code +  and wait until the green light flashes, then turns to continuously illuminated and the red light starts flashing	 	 
- When the red light has stopped flashing, the door will open up to an angle of approximately 20°		

6.2.2 Opening with delay

Red light

Green light

- Type an opening code +  and wait until the green and the red lights are flashing



- When the lock emits a beep every second, enter the opening code again



- When the red light has stopped flashing, the door will open up to an angle of approximately 20°



Wrong code penalty:



- Entry of 3 successive incorrect codes will result in a 10 minute operation blocking of the lock (any additional entry during the blocking period, will be recognized as an incorrect code).*











- Entry of 4 successive incorrect codes will result in a 20 minute operation blocking of the lock.

- Any additional incorrect code entry will result in a 30 minute blocking period.











- The C.I.T operators have immediate access with no time delay.

- **IMPORTANT:** After the first opening, the simple factory master code (000000) must be replaced by a safer one.

6.2.3 Dual access opening without delay (four eyes mode)

	Red light	Green light
➤ Type an opening code + 		 X2
➤ When the lock beeps every second, type in a second code opening + 		
➤ When the red light has stopped flashing, the door will open		

6.2.4 Dual access opening with delay (four eyes mode)

	Red light	Green light
➤ Type an opening code + 		 X2
➤ When the lock beeps every second type in a second Opening code + 		
➤ When the lock beeps every second type in again the second opening code + 		
➤ When the red light has stopped flashing, the door will open		

6.2.5 Securing the door

Red light

Green light

- Close the door.
- The door is bolted and secured.



IMPORTANT:

- When closing the door, do not place hand on the top of the door but push the door with the hand as shown below.

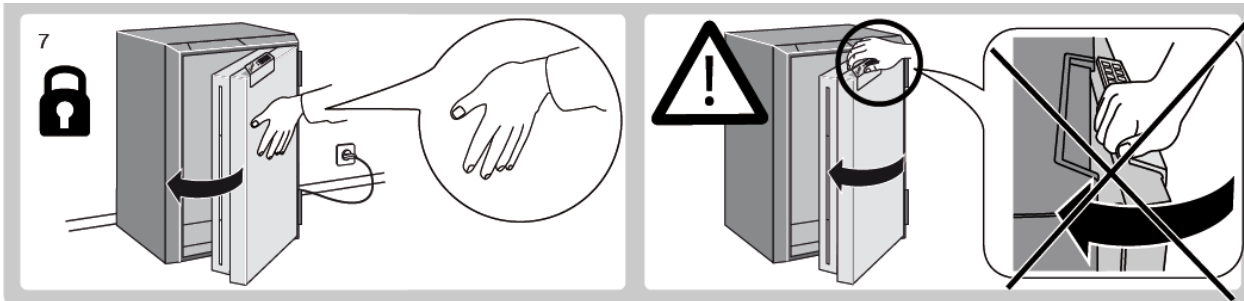



















7- CHANGING AN OPENING CODE

Configuration of the system (advanced user).



IMPORTANT: Keep the door open while changing of configuration.

7.1 Changing an opening code

- | | Red light | Green light |
|---|---|---|
| ➤ Type the master code +  |  |  |
| ➤ When the red light has stopped flashing, the door will open |  |  |
| ➤ * With the door open, type in the master code again +  |  |  |
| ➤ Select one operator (9 possibilities) by typing: | | |
| ▪ "0" +  for master code | | |
| Or | | |
| ▪ "1" +  for operator 1 | | |
| Or | | |
| ▪ "7" +  for operator 7 | | |
| Or | | |
| ▪ "8" +  for C.I.T operator | | |
| ➤ Type in the new code +  |  |  |
| ➤ Type in the new code again +  |  |  |

Throw the locking blade from the door and test at least "3" times the new code (See throw the bolt procedure on page 29.)



















- If you need to modify another setting, go back to point * and repeat the operations.

- An opening code can be made up of 6, 7, or 8 digits.

- You can modify the code even if the operator is not activated.

8-ACTIVATING AND DEACTIVATING OPERATORS

8.1 Activating operators



















	Red light	Green light
➤ Type in the master code + 		
➤ When the red light has stopped flashing, the door will open		
➤		
➤ *With the door open, type in the master code again + 		
➤ Type "9" + 		
➤		
➤ Select an operator (8 possibilities) by typing :		
▪ "1" +  for operator 1		
Or		
▪ "2" +  for operator 2		
Or		
▪ "7" +  for operator 7		
Or		
▪ "8" +  for C.I.T operator		
➤ Type "1" +  "The operator's code is now activated."		

- If you wish to modify another setting, go back to point * and repeat the operations.



Once an operator code has been activated for the first time, change the factory (or default) code by a safer one.

8.2 Deactivating operators

	Red light	Green light
➤ Type in the master code + 		
➤ When the red light has stopped flashing, the door will open		
➤ *With the door open type in the master code again + 		
➤ Type "9" + 		
➤ Select an operator (8 possibilities) by typing :		
▪ "1" +  for operator 1		
Or		
▪ "2" +  for operator 2		
Or		
▪ "7" +  for operator 7		
Or		
▪ "8" +  for C.I.T operator		
➤ Type "0" + 		
"The operator's code is now deactivated."		

- If you wish to modify another setting, go back to point * and repeat the operations.

















Even if a deactivated code does not allow the opening, it is in memory.















9-SETTING DELAYS

The lock allows the user to set a delay before opening: When a code is entered, a delay timer is counted down before the bolt releases. The delay timer can be set from “0” to “99” minutes.

9.1 Master code delay

	Red light	green light
➤ Type in the master code + 		
➤ When the red light has stopped flashing, the door will open		
➤ With the door open, type in the master code again + 		
➤ Type “13” + 		
➤ Type delay duration in minutes + 		















9.2 Operator delay

	Red light	Green light
➤ Type in the master code + 		
➤ When the red light has stopped flashing, the door will open		
➤ With the door open, type in master code again + 		
➤ Type "14" + 		
➤ Type delay duration in minutes + 		

10-DUAL ACCESS OPENING (4 eyes mode)

In this mode, two different codes have to be entered to release the opening of the lock.

10.1 Activating the dual access opening mode (4 eyes mode)

	Red light	Green light
➤ Type in the master code + 		
➤ When the red light has stopped flashing, the door will open		
➤ With the door open, type in the master code again + 		
➤ Type "12" + 		
➤ Type "1" +  The function is activated		



Even if the dual access mode is activated, the master code or the C.I.T code alone allows the unlocking of the door.

















When in dual access mode, the delay applied before opening is the one of the second code entered.

10.2 Deactivating dual access opening mode (4 eyes)

Red light

Green light















-
- | | | |
|---|---|---|
| ➤ Type in the master code +  |  |  |
| ➤ When the red light has stopped flashing, the door will open |  |  |
| ➤ With the door open, type in the master code again +  |  |  |
| ➤ Type "12" +  |  |  |
| ➤ Type "0" + 
The function is deactivated |  |  |

11- RECONFIRMING THE CODE















The lock opening time delay setting can either be set to open automatically after the elapsed delay period, or that re-entry of the code is required after the delay period, in order to open the lock.

The default setting of the lock is: code reconfirmation activated, refer to chapter 6 “factory setting”.

11.1 Activating the code reconfirmation after delay

	Red light	Green light
➤ Type in the master code + 		
➤ When the red light has stopped flashing, the door will open		
➤ With the door open, type in the master code again + 		
➤ Type “17” + 		
➤ Type “1” + 		















11.2 Deactivating the code reconfirmation after delay

	Red light	Green light
➤ Type in the master code + 		
➤ When the red light has stopped flashing, the door will open		
➤ With the door open, type in the master code again + 		
➤ Type "17" + 		
➤ Type "0" + 		

12-BUZZER

The lock can be set to silent mode (buzzer off)















12.1 Activating the buzzer

	Red light	Green light
➤ Type in the master code + 		
➤ When the red light has stopped flashing, the door will open		
➤ With the door open, type in master code again + 		
➤ Type "10" + 		
➤ Type "1" +  The function is activated.		



Warning: The silent mode being far less user friendly, we recommend using this function only when strictly required and only for well-trained advanced users.

12.2 Deactivating the buzzer

	Red light	Green light
➤ Type in the master code + 		
➤ When the red light has stopped flashing, the door will open		
➤ With the door open, type in the master code again + 		
➤ Type "10" + 		
➤ Type "0" +  The function is deactivated.		



The alarm and warning signals sounds remain active when the buzzer is off. (Please refer to the troubleshooting section).

13- TROUBLESHOOTING

- The red led blinks three times when pressing a key.

- The lock is in a blocked state (at least 3 wrong codes were entered successfully): wait until the end of the blocking period and try again (please refer to page 13 of the manual).
- The opening mechanism is jammed: please contact your retailer.

- The red led flashes with a dual tone sound.

- The opening mechanism is jammed, please contact your retailer.

-Green and red led both flash simultaneously and the lock beeps twice on every flash.

- The communication between the keypad and the security unit (inside the safe) is no longer established: please contact your retailer.

14- WARRANTY

If needed, your reseller is the first person able to assist.

If he cannot be contacted (if you have moved), or if the store you bought your safe from has closed... please contact the Gunnebo after-Sales Service who will indicate the nearest address of a qualified service engineer.

15- MAINTENANCE PERIODS

“We recommend a maintenance visit at least every 2 years”

If your safe requires servicing, always request **Professional Gunnebo Certified service engineer and spare parts.**

Before calling the After-Sales Service, please check the model and the serial number of the safe which is located either on the inner face of the door, or on the outer body of the safe.



If the original factory parts are not used in any service visit, the warranty will be invalid.

16- FACTORY SETTINGS

Default factory settings

		Default opening code	
Code configuration	Master	000000	Active
	Operator 1	111111	Inactive
	Operator 2	222222	Inactive
	Operator 3	333333	Inactive
	Operator 4	444444	Inactive
	Operator 5	555555	Inactive
	Operator 6	666666	Inactive
	Operator 7	777777	Inactive
	C.I.T operator	888888	Inactive

Delay	Master code delay	0 min
	Operator delay	0 min

General settings	Buzzer	Active
	Dual access (4 eyes mode)	Inactive
	Relayed output cable	Inactive
	Code reconfirming	Active

17- THROW THE LOCKING BLADE (page 16)

To throw the locking blade of the door and simulate the closing of the safe proceed as described below:

1-Door open, locate on the back side of the door, top right and below the keypad the window of the bolt throw command.

2-Insert the simulation tool as shown on the drawing below.

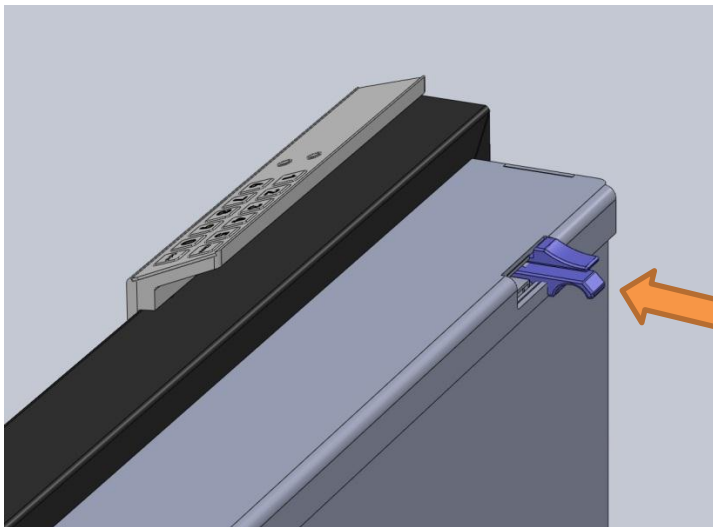

3-The bolt will throw and you will be able to check at least 3 times the opening of the lock and the mechanism.

4-Remove the simulation tool and close the door of the safe.

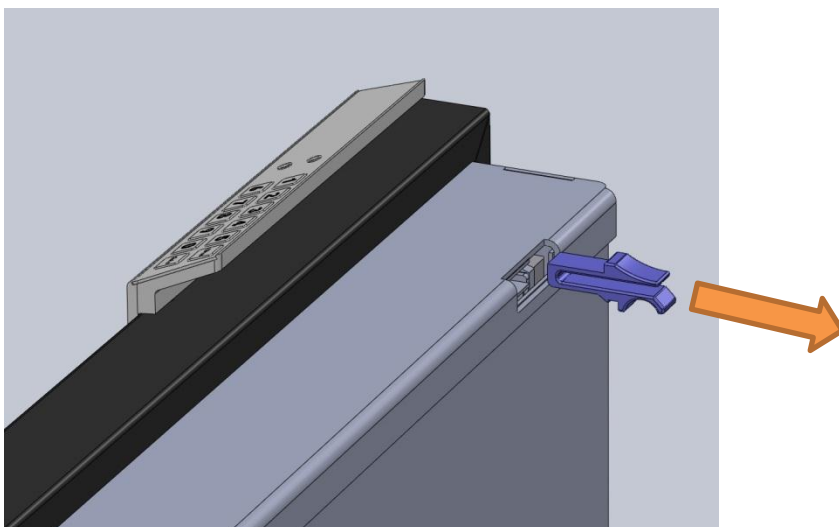

5- The door, the lock and the mechanism will lock automatically.

18- WARNINGS AND PRECAUTIONS



WARNING !

Packaging material can cause suffocation and injury if used incorrectly.

- Never let the children play with the packaging unsupervised?



WARNING :

Danger of injury from improper transport

The safe itself is very heavy. If it falls while being transported or installed incorrectly, it can cause serious injuries to the feet and hands.

- Transport the safe on a strong base (such as a pallet, for example). Fasten it with belts or strapping to prevent it from falling.
- Wear protective gloves during transport.
- Only transport the safe with suitable aids (e.g. a jack lift).
- Only remove the strapping and pallet at the installation site.



WARNING ! AFTER SALES SERVICE ACTION

Danger of being crushed by moving components of the locking mechanism behind the bolted cover flap.

Crushing of fingers or hands.

- The cover may only be opened by trained persons.
- Never perform maintenance or repair work without authorization.



WARNING !

**Only professional engineers should service the safe.
Switch off the device and unplug the mains plug before opening the cover flap!**

WARNING !

Danger of being crushed by turning toothed wheels when performing work while the machine is switch on!

Crushing the fingers or hands

- Switch off the machine before beginning work.
- Before activating the locking mechanism, make sure that hands and / or fingers cannot be crushed.



WARNING !

Danger of being crushed by the safe if it falls because the installation location has insufficient bearing capacity

Crushing

- Before installation / set up, ensure that the installation location has sufficient weight bearing capacity.
- Never install by means of wall mounting (e.g. on a bracket)
- Never install in or on items of furniture.



WARNING !

Danger of fatal injury from electric current (service engineers)

There is an immediate danger of fatal injury from electric shock if live parts are touched. Damaged insulation or single components can be life-threatening.

- Only allow work on the electrical system to be performed by electricians.
- If the insulation is damaged then immediately disconnect the voltage supply and have repairs carried out.
- Before starting work on active parts of electronic systems and operating equipment, place them in a current-free state and ensure that they remain so for the duration of the work. Observe 5 safety rules while doing so
- Disconnect.
- Secure against unintended switch on.
- Determine whether the device is without voltage.

Earth and short circuit.

- Cover or fit barriers around live parts in the vicinity.
- Never bypass or disable fuses. Observe the correct current strength when replacing fuses.
- Keep moisture away from live parts. This can result in short-circuiting.



DANGER!

Electrical components coming into contact with water (splashing or spraying water)!

- Never clean the safe with liquid



WARNING!

Never try to replace the battery of your safe on your own; this must be done by a professional authorized engineer.

Please contact your distributors or our local Gunnebo service organization.

IMPORTANT : Never use an incorrect type of battery.



WARNING!

Danger of fatal injury from electric current!

If power cables or plugs are damaged, there is a danger of coming into contact with live parts. There is a fatal injury from electric shock.

- In case of damage to the cable or plug, switch off the device, disconnect it from the power supply and have the device repaired.
- Never operate the device with damaged cable.